



The founder and pioneer of
lithium battery manufacturing in China



WUHAN FANSO TECHNOLOGY CO., LTD

Address: No.1 Sitai Industrial Park, Yongfeng Avenue, Hanyang District, Wuhan city, China

Pc: 430051 Tel: 86-27-84452919 84458098 Fax: 86-27-84453116

Http://www.fansobattery.com Email.fanso@fansobattery.com



Li-MnO₂ Battery



www.fansobattery.com

201312



Founded in 2002 by Mr. Dai Jianghua, an initiator of primary lithium battery in China, FANSO with experienced specialists and technicians in this field is a most qualified manufacturer of primary lithium batteries in China.

Owing to a team of industry specialists for over 30 years and senior experts among the first to be involved in lithium battery, FANSO BATTERY is always able to keep up with customers' evolving needs. FANSO has been the first to introduce primary lithium battery into civil and military use.

FANSO is a leader in the design and manufacture of primary lithium batteries. 3.6V high power Li-SOCl₂ product range by FANSO has been listed in The National Torch Program. High temperature range (165℃) is an ideal alternative to replace products abroad. FANSO firstly set a manufacturer's standard of high-temperature lithium battery, filling the gap in domestic industry. FANSO high temperature range with high discharge stability and safety is classified into moderate temperature(125℃), high temperature (150℃) and limiting temperature(200℃), in the testing phase). FANSO BATTERY is currently increasing the sales in North America and Middle East, while FANSO has been a well-known Chinese brand of lithium battery in America(The US Trademark Registration NO.:771058671). In addition, FANSO BATTERY is ISO9001, UL, CE, RoHS, MA, UN and many other international standards certified, our batteries are underwritten by People's Insurance Company of China (PICC).

Our main products are 3.6V Li-SOCl₂ product range and 3.0V Li-MnO₂ product range. Equipped with 14 advanced production lines, we have the manufacturing capability of 28 million pcs annually. Besides 500,000 pieces per year can be yielded by the most exclusively advanced production line for high temperature batteries.

FANSO wins the recognition and trust from customers home and abroad by striving for first-class technology, reliable quality and best service. Our batteries are mainly applied to civilian market—LWD&MWD for oil exploration, electronic pressure gauge, flow meter, tire pressure monitoring system, smart meter, RFID, TPMS, RAM and CMOS circuit, geothermal heat detector, and military fields—aerospace, underwater ordnance, sonar, GPS and various force stations.

FANSO sticks to continuously refining and innovating, satisfying our customers by utmost service. Choose FANSO, choose what you need.

Overview

Model	Size	Max Dimensions (φ mmXmm)	Weight (g)	Nominal Voltage (V)	Nominal Capacity\ Current (mAh\mA)	Max Continuous Discharge Current (mA)	Operating Temperature (°C)	End Voltage (V)
Bobbin Type								
CR14250E	1/2AA	14.5X25.2	8.5	3	650\5	250	-30~+60	2.0
CR14505E	AA	14.5X50.5	17	3	1400\5	1000	-30~+60	2.0
CR17335E	2/3A	17.0X33.5	17	3	1350\5	1000	-30~+60	2.0
CR17450E	AG	17.0X45.0	26	3	2200\10	1000	-30~+60	2.0
CR17505E	A	17.0X50.5	30	3	2400\10	1000	-30~+60	2.0
CR26500E	C	26.2X50.5	55	3	5000\10	1000	-30~+60	2.0
CR34615E	D	34.0X61.5	125	3	12000\10	2000	-30~+60	2.0
CR2		15.5X27.0	13	3	850\5	800	-30~+60	2.0
CR-P2		35X19.5X36	42	6	1400\10	1000	-30~+60	4.0
CR123A		17.0X34.5	16	3	1500\5	1000	-30~+60	2.0

Spiral Type								
Model	Size	Max Dimensions (φ mmXmm)	Weight (g)	Nominal Voltage (V)	Nominal Capacity (mAh)	Max Continuous Discharge Current (mA)	Operating Temperature (°C)	End Voltage (V)
CR14250H	1/2AA	14.5X25.2	12	3	950	7	-30~+60	2.0
CR14505H	AA	14.5X50.5	23	3	2000	15	-30~+60	2.0
CR17335H	2/3A	17.0X33.5	21	3	1800	8	-30~+60	2.0
CR17505H	A	17.0X50.5	30	3	2700	20	-30~+60	2.0

Ultra Thin Cells								
Model	Size	Max Dimensions (φ mmXmm) (L) X (W) X (T)	Weight (g)	Nominal Voltage (V)	Nominal Capacity\ Current (mAh\mA)	Max Continuous Discharge Current (mA)	Operating Temperature (°C)	End Voltage (V)
CP073040		40.5X31.0X0.9	1.2	3	500\0.3	1	-20~+60	1.8
CP502025		25.5X20.5X5.2	4	3	400\1.0	30	-20~+60	1.8
CP204440		40.5X44.5X2.2	4.3	3	500\1.0	45	-20~+60	1.8
CP502425		25.5X24.5X5.2	5.5	3	550\1.0	40	-20~+60	1.8
CP203047		47.5X35.5X2.2	5	3	650\1.0	200	-20~+60	1.8
CP224147		48.3X45.5X2.2	6.5	3	800\1.0	200	-20~+60	1.8
CP502440		40.5X24.5X5.2	7.8	3	1200\1.0	120	-20~+60	1.8
CP383047		47.5X30.5X4.0	9.5	3	1350\5.0	400	-20~+60	1.8
CP305050		50.5X56.5X3.2	14	3	1600\5.0	600	-20~+60	1.8
CP504644		44.5X46.5X5.2	17	3	2300\5.0	1000	-20~+60	1.8
CP505050		50.5X50.5X5.2	23	3	3000\10	1200	-20~+60	1.8
CP-9V		49.5X27.3X18.0	29	9	1200\1.0	120	-20~+60	5.4



Cylindrical Li/MnO₂ Battery with High Power



Key features

- High and stable operating voltage
- Low self-discharge rate (less than 2% at 20 °C)
- Nickel-clad steel container
- Hermetic glass-to-metal sealing
- Compliant with IEC86-4 safety standard
- Non-restricted for transport

Main appliances

- Alarm and security devices
- Smoke detector
- Memory back-up power
- Real-time clock
- Professional electronics
- Medical

Storage: The storage area should be clean, cool (preferably below +20°C, not exceeding +30°C), dry and ventilated.

Model	Size	Max Dimensions (φ mm X mm)	Weight (g)	Nominal Voltage (V)	Nominal Capacity/Current (mAh / mA)	Max Continuous Discharge Current (mA)	Operating Temperature (°C)	End Voltage (V)
CR14250E	1/2AA	14.5X25.2	8.5	3	650/5	250	-30~+60	2.0
CR14505E	AA	14.5X50.5	17	3	1400/5	1000	-30~+60	2.0
CR17335E	2/3A	17.0X33.5	17	3	1350/5	1000	-30~+60	2.0
CR17450E	AG	17.0X45.0	26	3	2200/10	1000	-30~+60	2.0
CR17505E	A	17.0X50.5	30	3	2400/10	1000	-30~+60	2.0
CR26500E	C	26.2X50.5	55	3	5000/10	1000	-30~+60	2.0
CR34615E	D	34.0X61.5	125	3	12000/10	2000	-30~+60	2.0
CR2		15.5X27.0	13	3	850/5	800	-30~+60	2.0
CR-P2		35X19.5X36	42	6	1400/10	1000	-30~+60	4.0
CR123A		17.0X34.5	16	3	1500/5	1000	-30~+60	2.0

Warning: Do not recharge, short circuit, crush, disassemble, heat above 100°C, incinerate, or expose contents to water. Dispose of used batteries properly in case of explosion, burn and leakage.

CR14250E

Performance data

(Typical values relative to cells stored for one year or less at 30°C max)

- Nominal capacity 650mAh
(at 5mA +25°C 2.0V cut-off)
- Nominal voltage 3.0V
- Max. continuous current 250mA
(At +25°C 2.0V cut-off, up to 50% of nominal capacity)
- Max. pulse current 500mA
15 second pulses to 2.0V cut-off,
(drained from half-discharged cells at 5mA, 25 °C)
- Operating temperature range -30°C~+60°C
- Weight Approx. 8.5g

Typical discharge curves at 25°C

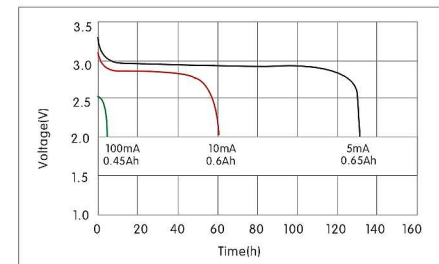

Capacity vs. Current and Temperature

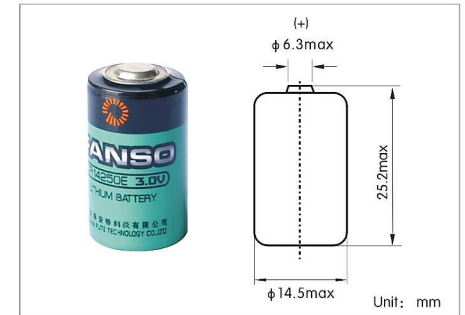
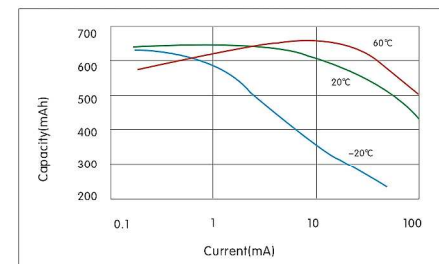

- Terminals: -/P Axial pins
 -/T/PT2 Radial pins
 -/PT/TP Polarized tags
 Customized designs are available

Voltage vs. Current and Temperature

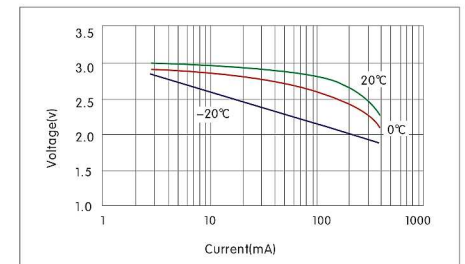

Storage Characteristics

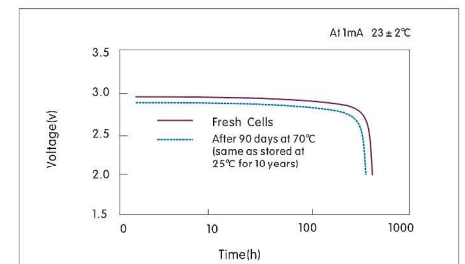



CR14505E

Performance data

(Typical values relative to cells stored for one year or less at 30°C max)

- Nominal capacity 1400mAh
(at 5mA +25°C 2.0V cut-off)
- Nominal voltage 3.0V
- Max. continuous current 1000mA
(At +25°C 2.0V cut-off, up to 50% of nominal capacity)
- Max. pulse current 2500mA
15 second pulses to 2.0V cut-off,
(drained from half-discharged cells at 5mA, 25 °C)
- Operating temperature range -30°C~+60°C
- Weight Approx. 17g

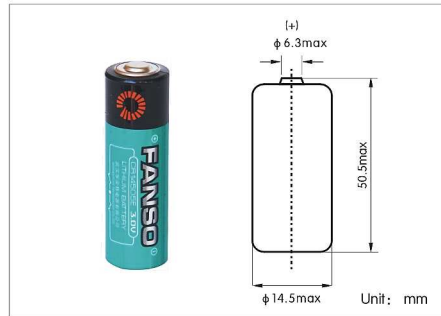

Terminals: -/P Axial pins
 -/T/PT2 Radial pins
 -/PT/TP Polarized tags
 Customized designs are available

Typical discharge curves at 25°C

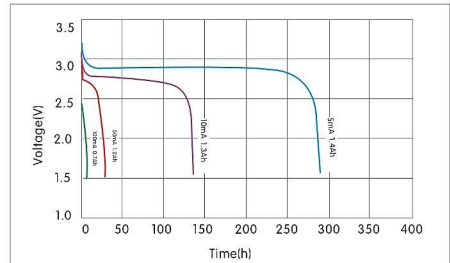

Voltage vs. Current and Temperature

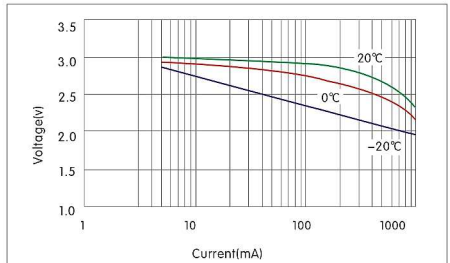

Capacity vs. Current and Temperature

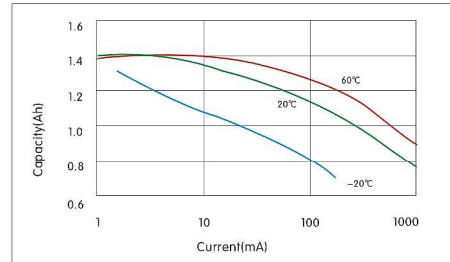

Storage Characteristics

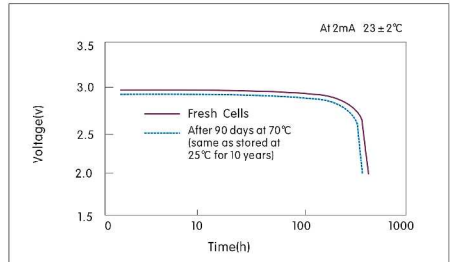

CR17335E

Performance data

(Typical values relative to cells stored for one year or less at 30°C max)

- Nominal capacity 1350mAh
(at 5mA +25°C 2.0V cut-off)
- Nominal voltage 3.0V
- Max. continuous current 1000mA
(At +25°C 2.0V cut-off, up to 50% of nominal capacity)
- Max. pulse current 2500mA
15 second pulses to 2.0V cut-off,
(drained from half-discharged cells at 5mA, 25 °C)
- Operating temperature range -30°C~+60°C
- Weight Approx. 17g

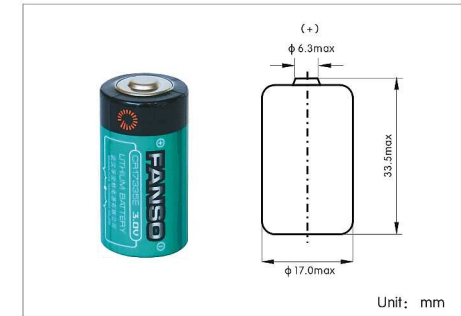

Terminals: -/P Axial pins
 -/T/PT2 Radial pins
 -/PT/TP Polarized tags
 Customized designs are available

Typical discharge curves at 25°C

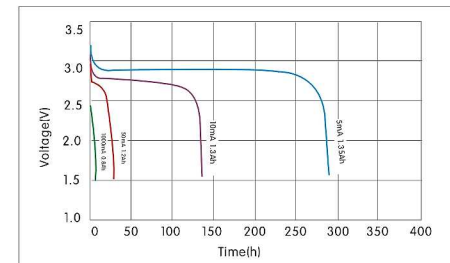

Voltage vs. Current and Temperature

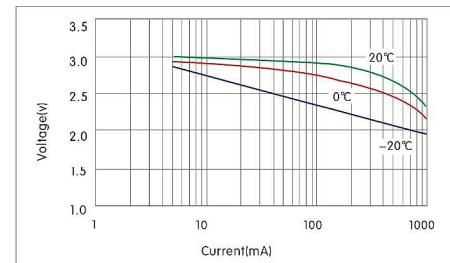

Capacity vs. Current and Temperature

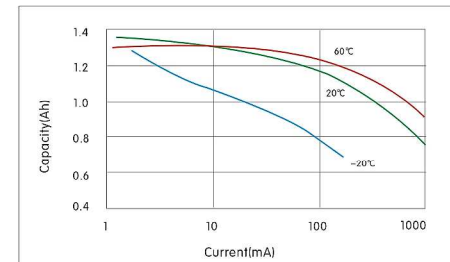

Storage Characteristics

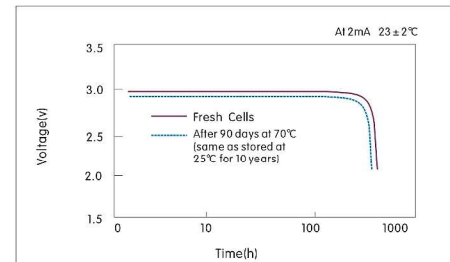



CR 123A

Performance data

(Typical values relative to cells stored for one year or less at 30°C max)

- Nominal capacity 1500mAh
(at 5mA +25°C 2.0V cut-off)
- Nominal voltage 3.0V
- Max. continuous current 1000mA
(At +25°C 2.0V cut-off, up to 50% of nominal capacity)
- Max. pulse current 2500mA
15 second pulses to 2.0V cut-off,
(drained from half-discharged cells at 5mA, 25 °C)
- Operating temperature range -30°C~+60°C
- Weight Approx. 16g

Typical discharge curves at 25°C

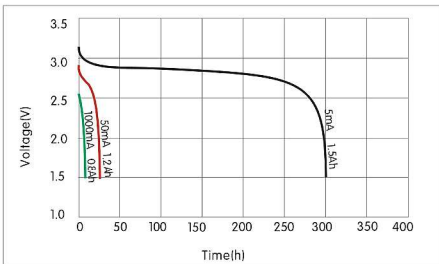

Capacity vs. Current and Temperature

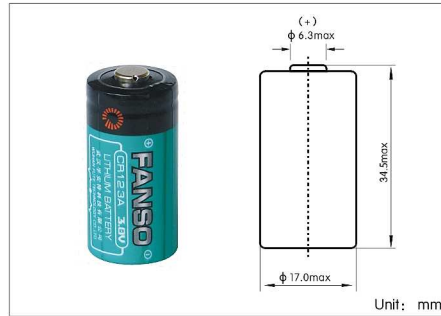
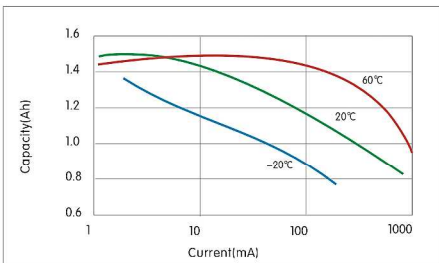

- Terminals: -/P Axial pins
 -/T/PT2 Radial pins
 -/PT/TP Polarized tags
 Customized designs are available

Voltage vs. Current and Temperature

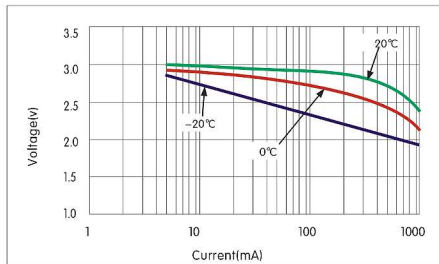

Storage Characteristics

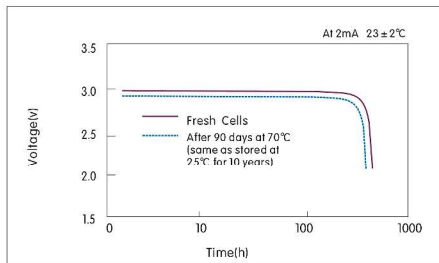

CR17450E

Performance data

(Typical values relative to cells stored for one year or less at 30°C max)

- Nominal capacity 2200mAh
(at 10mA +25°C 2.0V cut-off)
- Nominal voltage 3.0V
- Max. continuous current 1000mA
(At +25°C 2.0V cut-off, up to 50% of nominal capacity)
- Max. pulse current 2500mA
15 second pulses to 2.0V cut-off,
(drained from half-discharged cells at 10mA, 25 °C)
- Operating temperature range -30°C~+60°C
- Weight Approx. 26g

Typical discharge curves at 25°C

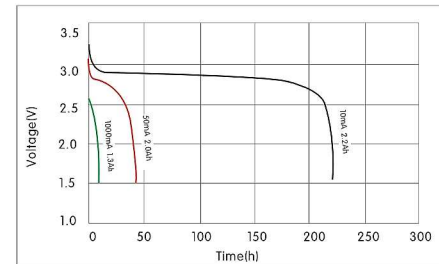

Capacity vs. Current and Temperature

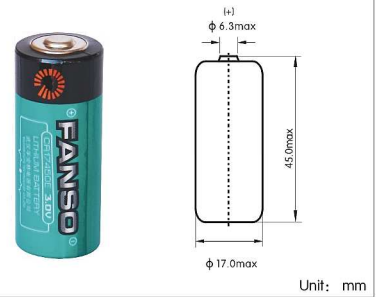
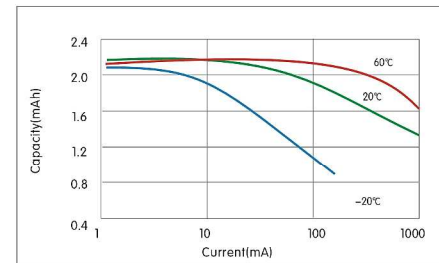

- Terminals: -/P Axial pins
 -/T/PT2 Radial pins
 -/PT/TP Polarized tags
 Customized designs are available

Voltage vs. Current and Temperature

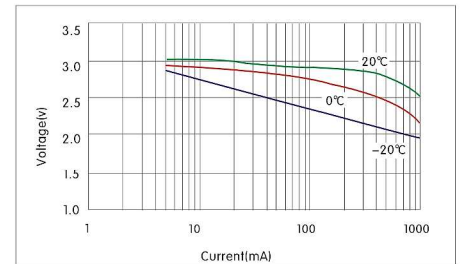

Storage Characteristics

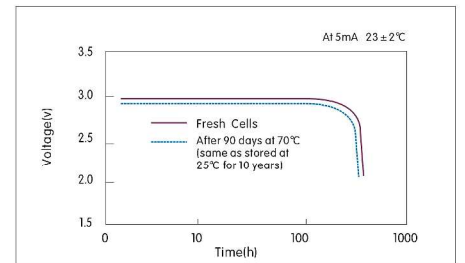



CR17505E

Performance data

(Typical values relative to cells stored for one year or less at 30°C max)

- Nominal capacity 2400mAh
(at 10mA +25°C 2.0V cut-off)
- Nominal voltage 3.0V
- Max. continuous current 1000mA
(At +25°C 2.0V cut-off, up to 50% of nominal capacity)
- Max. pulse current 2500mA
15 second pulses to 2.0V cut-off,
(drained from half-discharged cells at 10mA, 25°C)
- Operating temperature range -30°C~+60°C
- Weight Approx. 30g

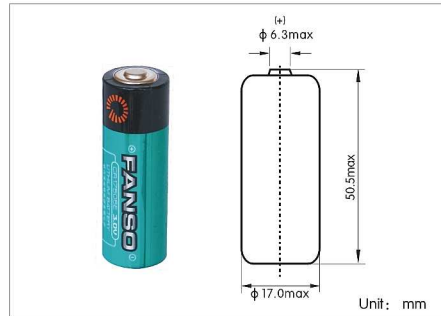

Terminals: -/P Axial pins
 -/T/PT2 Radial pins
 -/PT/TP Polarized tags
 Customized designs are available

Typical discharge curves at 25°C

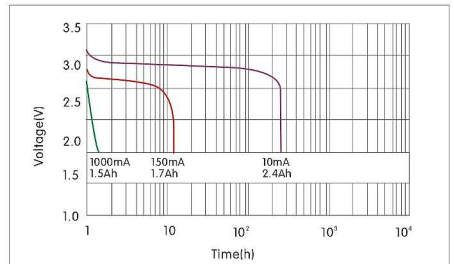

Voltage vs. Current and Temperature

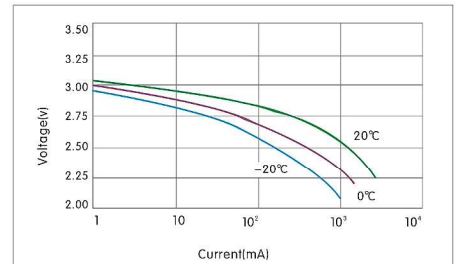

Capacity vs. Current and Temperature

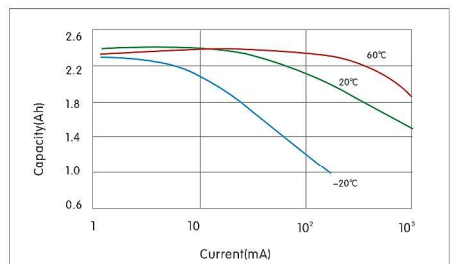

Storage Characteristics

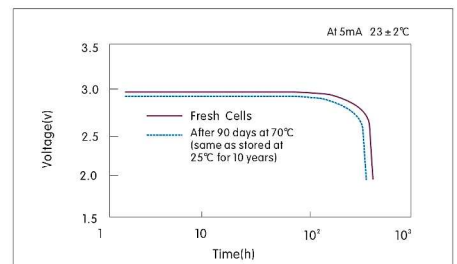

CR 26500E

Performance data

(Typical values relative to cells stored for one year or less at 30°C max)

- Nominal capacity 5000mAh
(at 10mA +25°C 2.0V cut-off)
- Nominal voltage 3.0V
- Max. continuous current 1000mA
(At +25°C 2.0V cut-off, up to 50% of nominal capacity)
- Max. pulse current 2000mA
15 second pulses to 2.0V cut-off,
(drained from half-discharged cells at 10mA, 25°C)
- Operating temperature range -30°C~+60°C
- Weight 约55g

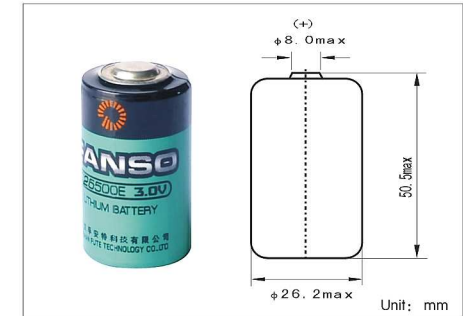

Terminals: -/P Axial pins
 -/T/PT2 Radial pins
 -/PT/TP Polarized tags
 Customized designs are available

Typical discharge curves at 25°C

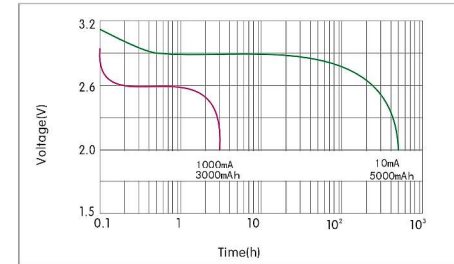

Voltage vs. Current and Temperature

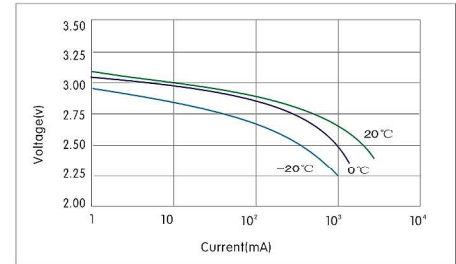

Capacity vs. Current and Temperature

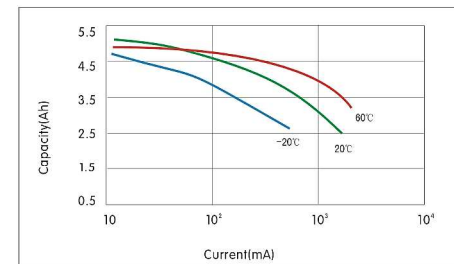

Storage Characteristics

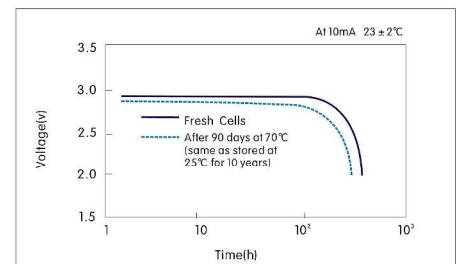



CR 34615E

Performance data

(Typical values relative to cells stored for one year or less at 30°C max)

- Nominal capacity 12000mAh
(at 10mA +25°C 2.0V cut-off)
- Nominal voltage 3.0V
- Max. continuous current 2000mA
(At +25°C 2.0V cut-off, up to 50% of nominal capacity)
- Max. pulse current 3000mA
15 second pulses to 2.0V cut-off,
(drained from half-discharged cells at 10mA, 25°C)
- Operating temperature range -30°C~+60°C
- Weight 约125g



Terminals: -/P Axial pins
 -/T/PT2 Radial pins
 -/PT/TP Polarized tags
 Customized designs are available

Typical discharge curves at 25°C

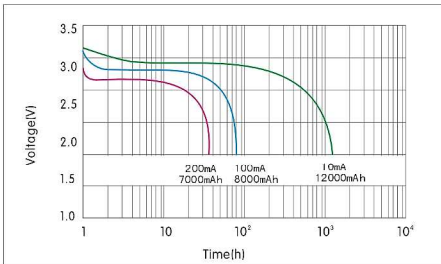

Voltage vs. Current and Temperature

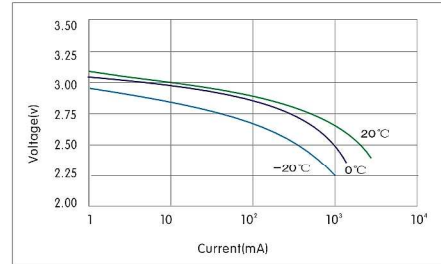

Capacity vs. Current and Temperature

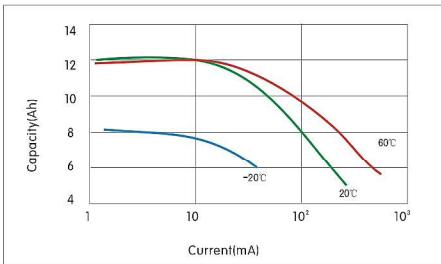

Storage Characteristics

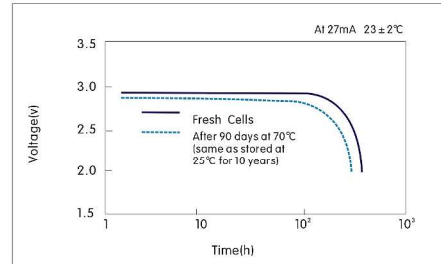

CR 2

Performance data

(Typical values relative to cells stored for one year or less at 30°C max)

- Nominal capacity 850mAh
(at 5mA +25°C 2.0V cut-off)
- Nominal voltage 3.0V
- Max. continuous current 800mA
(At +25°C 2.0V cut-off, up to 50% of nominal capacity)
- Max. pulse current 1500mA
15 second pulses to 2.0V cut-off,
(drained from half-discharged cells at 5mA, 25°C)
- Operating temperature range -30°C~+60°C
- Weight Approx. 13g

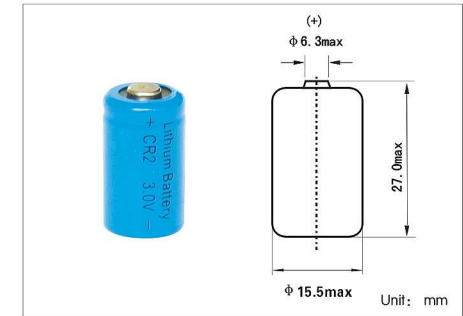

Terminals: -/P Axial pins
 -/T/PT2 Radial pins
 -/PT/TP Polarized tags
 Customized designs are available

Typical discharge curves at 25°C

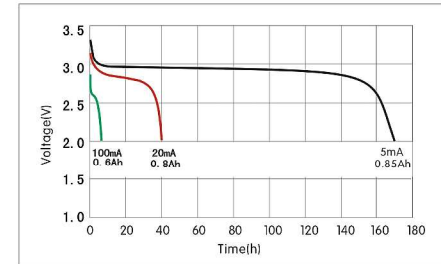

Voltage vs. Current and Temperature

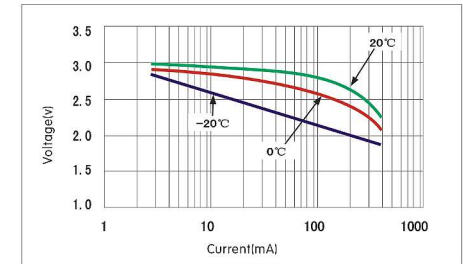

Capacity vs. Current and Temperature

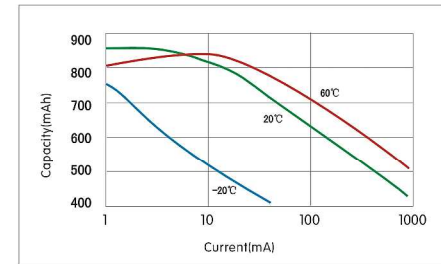

Storage Characteristics

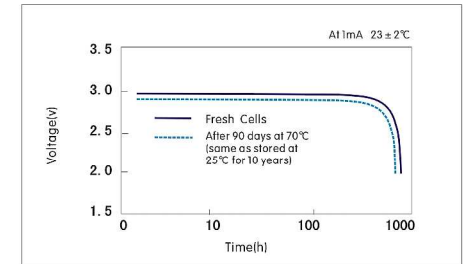

CR-P2

Performance data

(Typical values relative to cells stored for one year or less at 30°C max)

- Nominal capacity 1400mAh
(at 10mA +25°C 4.0V cut-off)
- Nominal voltage 6.0V
- Max. continuous current 1000mA
(At +25°C 4.0V cut-off, up to 50% of nominal capacity)
- Max. pulse current 2500mA
15 second pulses to 4.0V cut-off,
(drained from half-discharged cells at 10mA, 25°C)
- Operating temperature range -30°C~+60°C
- Weight Approx. 42g

Typical discharge curves at 25°C

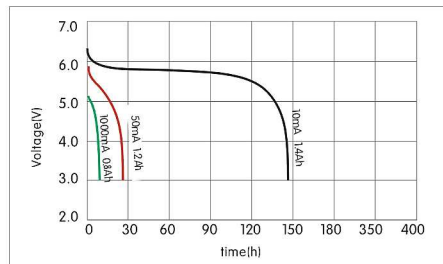

Capacity vs. Current and Temperature

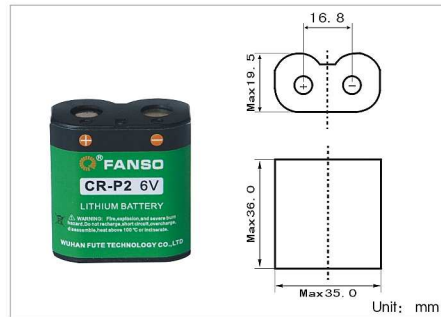
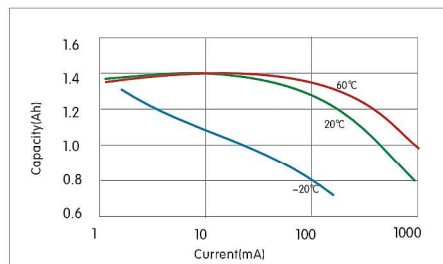

Customized designs are available

Voltage vs. Current and Temperature

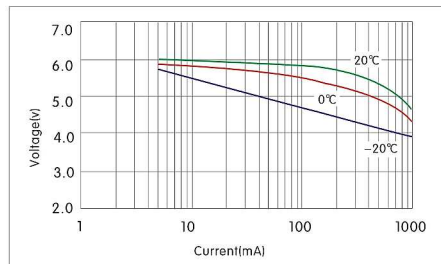

Storage Characteristics

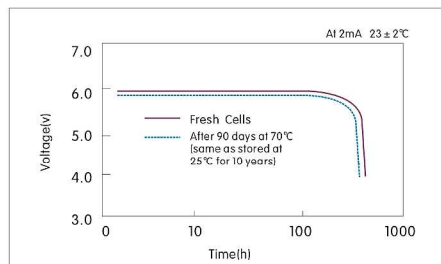

Cylindrical Li/MnO₂ Battery with High Capacity



Key features

- High and stable operating voltage
- Low self-discharge rate (less than 2% at 20°C)
- Nickel-clad steel container
- Hermetic glass-to-metal sealing
- Compliant with IEC86-4 safety standard
- Non-restricted for transport

Main appliances

- Alarm and security devices
- Smoke detector
- Memory back-up power
- Real-time clock
- Professional electronics
- Medical

Storage

The storage area should be clean, cool (preferably below +20°C, not exceeding +30°C), dry and ventilated.

Model	Size	Max Dimensions (φ mm×mm)	Weight (g)	Nominal Voltage (V)	Nominal Capacity (mAh)	Max Continuous Discharge Current (mA)	Operating Temperature (°C)	End Voltage (V)
CR14250H	1/2AA	14.5×25.2	12	3	950	7	-30~+60	2.0
CR14505H	AA	14.5×50.5	23	3	2000	15	-30~+60	2.0
CR17335H	2/3A	17.0×33.5	21	3	1800	8	-30~+60	2.0
CR17505H	A	17.0×50.5	30	3	2700	20	-30~+60	2.0

Warning: Do not recharge, short circuit, crush, disassemble, heat above 100°C, incinerate, or expose contents to water. Dispose of used batteries properly in case of explosion, burn and leakage.



CR14250H

Performance data

(Typical values relative to cells stored for one year or less at 30°C max)

- Nominal capacity 950mAh
(at 0.5mA +25°C 2.0V cut-off)
- Nominal voltage 3.0V
- Max. continuous current 7mA
(At +25°C 2.0V cut-off, up to 50% of nominal capacity)
- Max. pulse current 70mA
15 second pulses to 2.0V cut-off,
(drained from half-discharged cells at 0.5mA, 25°C)
- Operating temperature range -30°C~+60°C
- Weight Approx. 12g

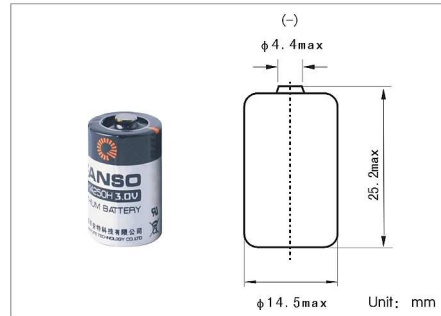

Terminals: -/P Axial pins
 -/T/PT2 Radial pins
 -/PT/TP Polarized tags
 Customized designs are available

Typical discharge curves at 25°C

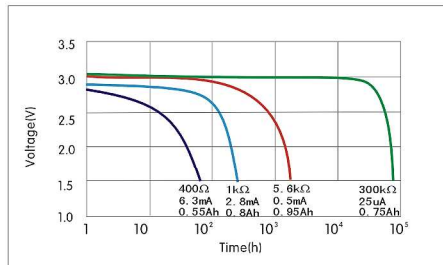

Voltage vs. Current and Temperature

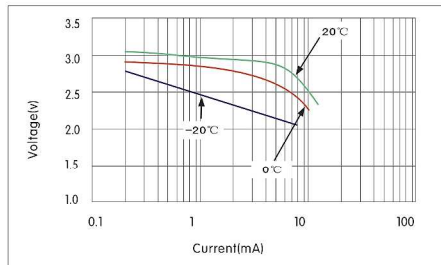

Capacity vs. Current and Temperature

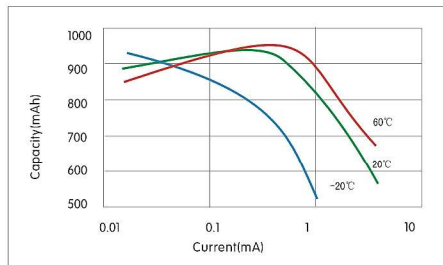

Storage Characteristics

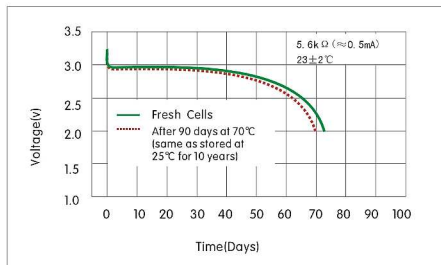

CR 14505H

Performance data

(Typical values relative to cells stored for one year or less at 30°C max)

- Nominal capacity 2000mAh
(at 1kΩ, +25°C 2.0V cut-off)
- Nominal voltage 3.0V
- Max. continuous current 15mA
(At +25°C 2.0V cut-off, up to 50% of nominal capacity)
- Max. pulse current 100mA
15 second pulses to 2.0V cut-off,
(drained from half-discharged cells at 1kΩ, 25°C)
- Operating temperature range -30°C~+60°C
- Weight Approx. 23g

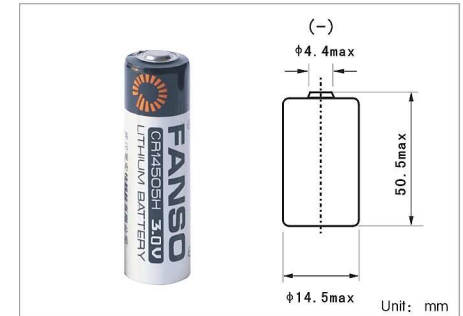

Terminals: -/P Axial pins
 -/T/PT2 Radial pins
 -/PT/TP Polarized tags
 Customized designs are available

Typical discharge curves at 25°C

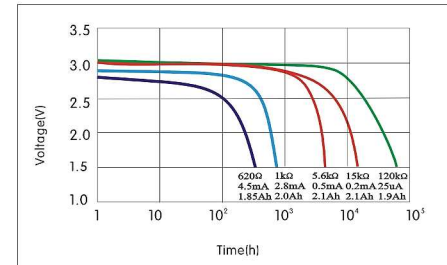

Voltage vs. Current and Temperature

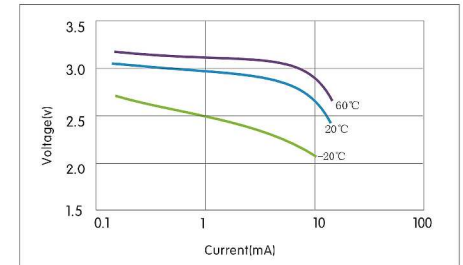

Capacity vs. Current and Temperature

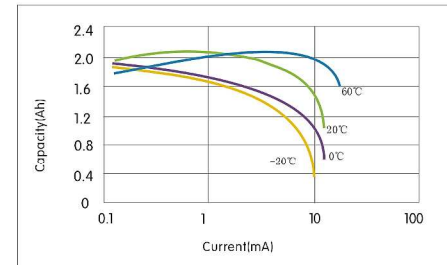

Storage Characteristics

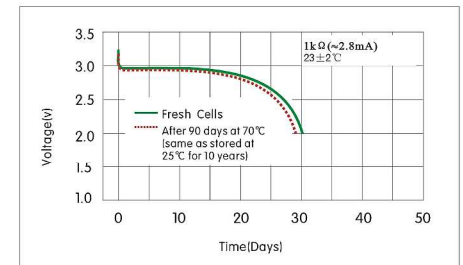



CR 1735H

Performance data

(Typical values relative to cells stored for one year or less at 30°C max)

- Nominal capacity 1800mAh
(at 5.6kΩ, +25°C 2.0V cut-off)
- Nominal voltage 3.0V
- Max. continuous current 8mA
(At +25°C 2.0V cut-off, up to 50% of nominal capacity)
- Max. pulse current 100mA
15 second pulses to 2.0V cut-off,
(drained from half-discharged cells at 5.6kΩ, 25°C)
- Operating temperature range -30°C ~ +60°C
- Weight Approx. 21g

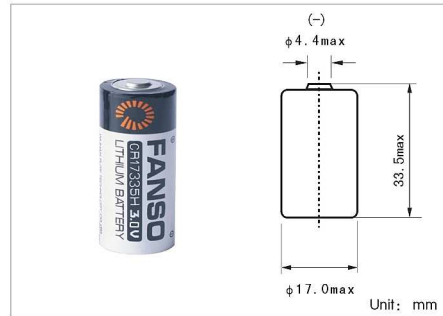

Terminals: -/P Axial pins
 -/T/PT2 Radial pins
 -/PT/TP Polarized tags
 Customized designs are available

Typical discharge curves at 25°C

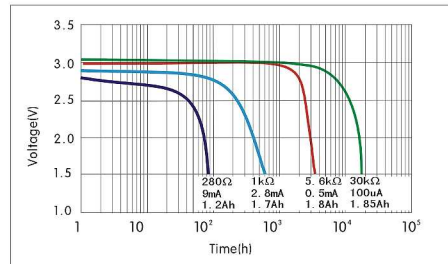

Voltage vs. Current and Temperature

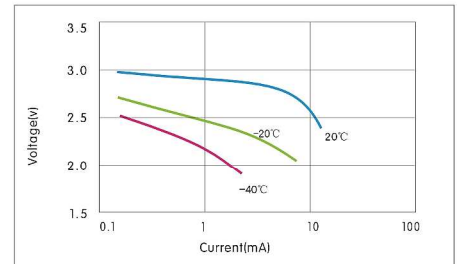

Capacity vs. Current and Temperature

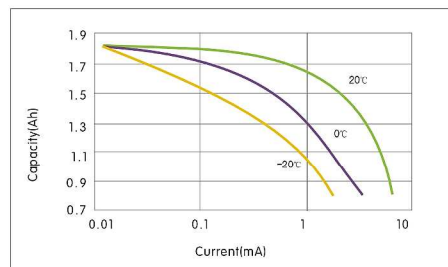

Storage Characteristics

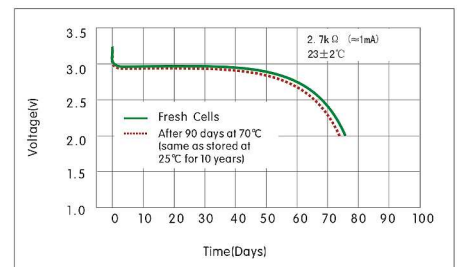

CR 17505H

Performance data

(Typical values relative to cells stored for one year or less at 30°C max)

- Nominal capacity 2700mAh
(at 1kΩ, +25°C 2.0V cut-off)
- Nominal voltage 3.0V
- Max. continuous current 20mA
(At +25°C 2.0V cut-off, up to 50% of nominal capacity)
- Max. pulse current 200mA
15 second pulses to 2.0V cut-off,
(drained from half-discharged cells at 1kΩ, 25°C)
- Operating temperature range -30°C ~ +60°C
- Weight Approx. 30g

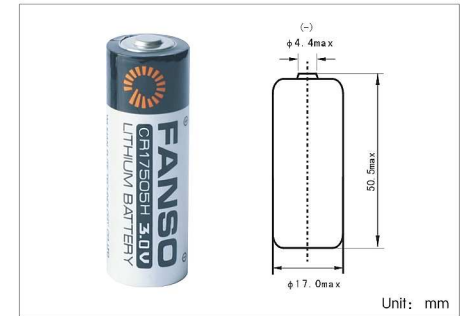

Terminals: -/P Axial pins
 -/T/PT2 Radial pins
 -/PT/TP Polarized tags
 Customized designs are available

Typical discharge curves at 25°C

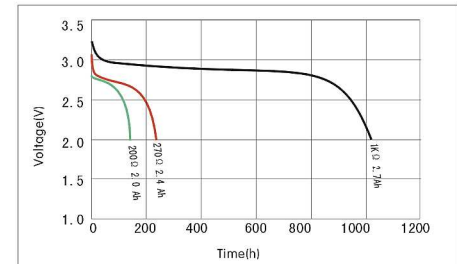

Voltage vs. Current and Temperature

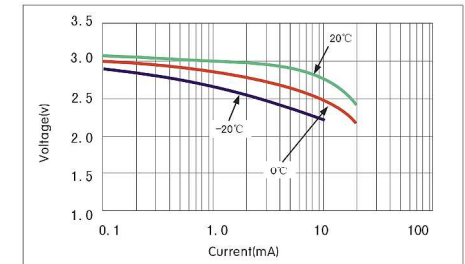

Capacity vs. Current and Temperature

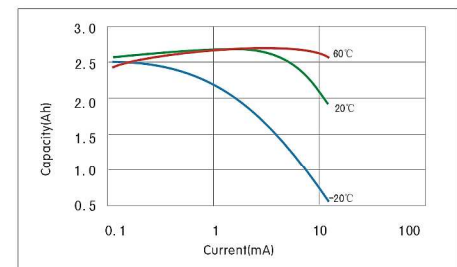

Storage Characteristics

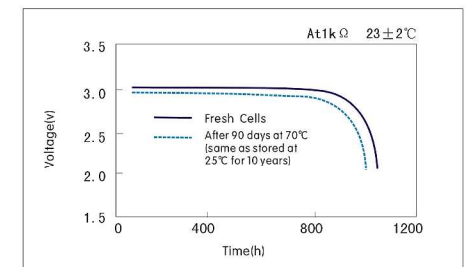

Soft package of 3.0V Li/MnO₂ battery



FANSO BATTERY is always specializing in research and development of primary lithium cells. Years of experience in researching and manufacturing give FANSO a leading place in this field. Rapid developments of RFID, wireless transmission, remote sensing and other technologies drive constant innovation of intelligent electronics industry. To meet the new market's demands, specialists from FANSO cooperating with well-known end users developed a more suitable range for RFID and others—flexible Li-MnO₂ soft pack batteries.

As flexible Li-MnO₂ soft pack batteries developed by FANSO BATTERY are ultra-thin, flexible in size, of high power densities, they are widely applied for RFID, Electronic identifier, smart card, container terminal, ETC, remote sensing etc.

Key features: ●High and stable operating voltage ●Low self-discharge rate (less than 2% at 20°C) ●Hermetic glass-to-metal sealing ●Compliant with IEC86-4 safety standard ●Non-restricted for transport

Main appliances: ●Active RFID tags ●Alarm and security systems ●Smoke detectors ●Memory back-up power ●Real-time clock ●Professional electronics ●Medical

The storage area should be clean, cool (preferably below +20°C, not exceeding +30°C), dry and ventilated.

Model	Size	Max Dimensions (g mm×mm) (L) X (W) X (T)	Weight (g)	Nominal Voltage (V)	Nominal Capacity Current (mAh/mA)	Max Continuous Discharge Current (mA)	Operating Temperature (°C)	End Voltage (V)
CP073040		40.5X31.0X0.9	1.2	3	50±0.03	1	-20~+60	1.8
CP502025		25.5X20.5X5.2	4	3	400±1.0	30	-20~+60	1.8
CP204440		40.5X44.5X2.2	4.3	3	500±1.0	45	-20~+60	1.8
CP502425		25.5X24.5X5.2	5.5	3	550±1.0	40	-20~+60	1.8
CP203047		47.5X35.5X2.2	5	3	650±1.0	200	-20~+60	1.8
CP224147		48.3X45.5X2.2	6.5	3	800±1.0	200	-20~+60	1.8
CP502440		40.5X24.5X5.2	7.8	3	1200±1.0	120	-20~+60	1.8
CP383047		47.5X30.5X4.0	9.5	3	1350±5.0	400	-20~+60	1.8
CP305050		50.5X56.5X3.2	14	3	1600±5.0	600	-20~+60	1.8
CP504644		44.5X46.5X5.2	17	3	2300±5.0	1000	-20~+60	1.8
CP505050		50.5X50.5X5.2	23	3	3000±10	1200	-20~+60	1.8
CP-9V		49.5X27.3X18.0	29	9	1200±1.0	120	-20~+60	5.4

Warning: Do not recharge, short circuit, crush, disassemble, heat above 100°C, incinerate, or expose contents to water. Dispose of used batteries properly in case of explosion, burn and leakage.

CP 502425

Performance data

(Typical values relative to cells stored for one year or less at 30°C max)

- Nominal capacity 550mAh (at 1mA +25°C 1.8V cut-off)
- Nominal voltage 3.0V
- Max. continuous current 40mA (At +25°C 1.8V cut-off, up to 50% of nominal capacity)
- Max. pulse current 150mA (15 second pulses to 1.8V cut-off, (drained from half-discharged cells at 1.0mA 25°C)
- Operating temperature range -20°C~+60°C
- Weight Approx. 5.5g

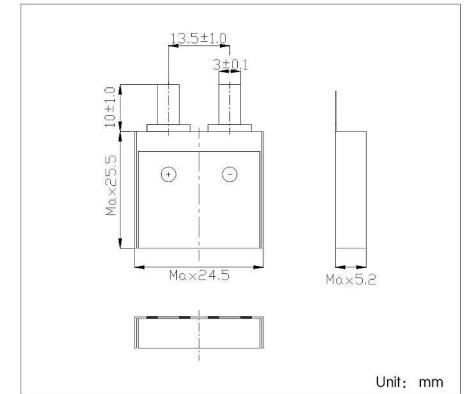

Unit: mm

Customized designs are available

Typical discharge curves at 25°C

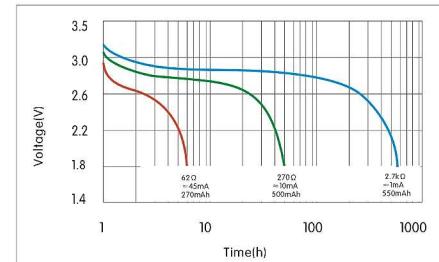

Voltage vs. Current and Temperature

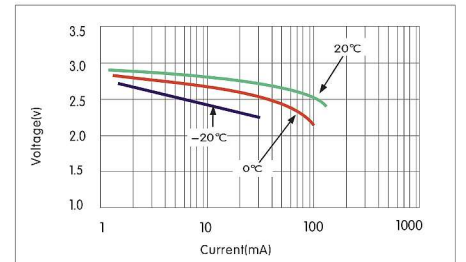

Capacity vs. Current and Temperature

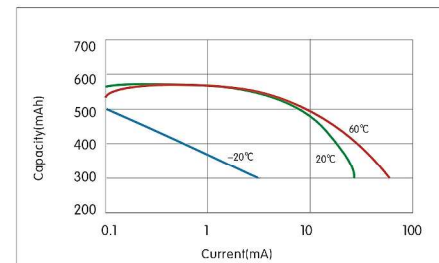

Storage Characteristics

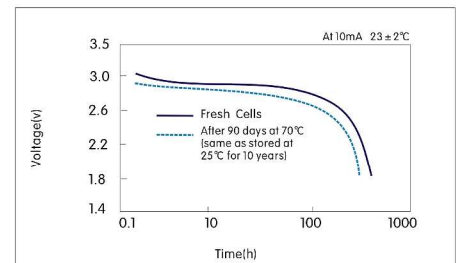



CP 203047

Performance data

(Typical values relative to cells stored for one year or less at 30°C max)

- Nominal capacity 650mAh
(at 1.0mA +25°C 1.8V cut-off)
- Nominal voltage 3.0V
- Max. continuous current 200mA
(At +25°C 1.8V cut-off, up to 50% of nominal capacity)
- Max. pulse current 400mA
15 second pulses to 1.8V cut-off,
(drained from half-discharged cells at 5mA 25°C)
- Operating temperature range -20°C~+60°C
- Weight Approx. 5.0g

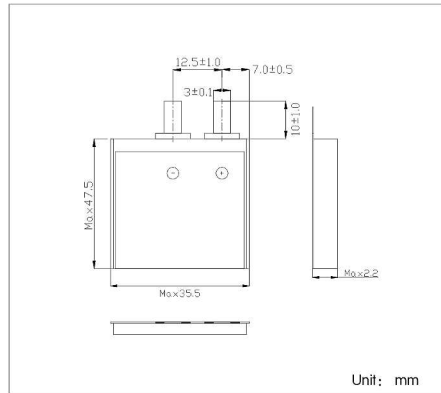

Unit: mm

Customized designs are available

Typical discharge curves at 25°C

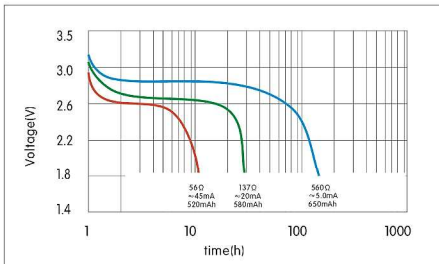

Voltage vs. Current and Temperature

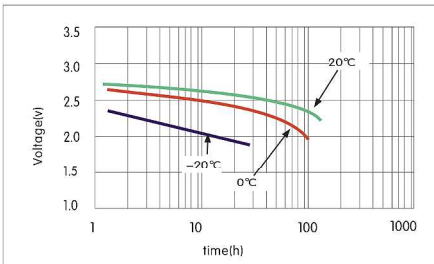

Capacity vs. Current and Temperature

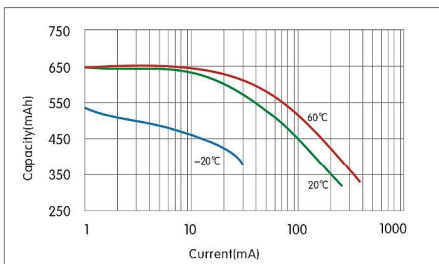

Storage Characteristics

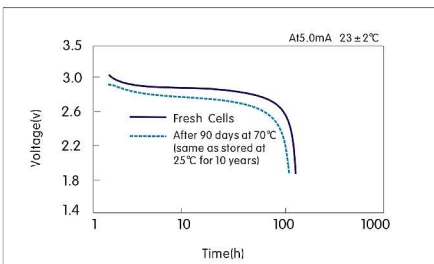

CP 224147

Performance data

(Typical values relative to cells stored for one year or less at 30°C max)

- Nominal capacity 800mAh
(at 1.0mA +25°C 1.8V cut-off)
- Nominal voltage 3.0V
- Max. continuous current 200mA
(At +25°C 1.8V cut-off, up to 50% of nominal capacity)
- Max. pulse current 400mA
15 second pulses to 1.8V cut-off,
(drained from half-discharged cells at 1.0mA 25°C)
- Operating temperature range -20°C~+60°C
- Weight Approx. 6.5g

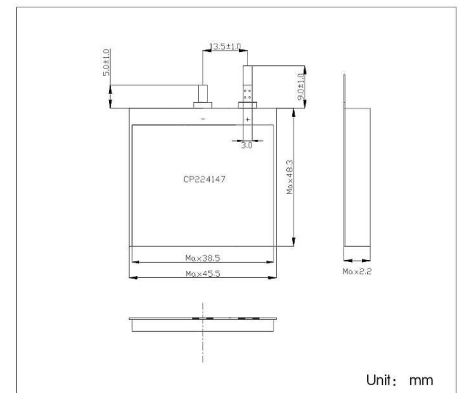

Unit: mm

Customized designs are available

Typical discharge curves at 25°C

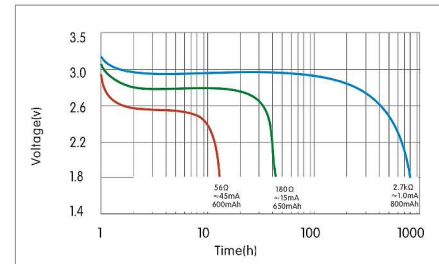

Voltage vs. Current and Temperature

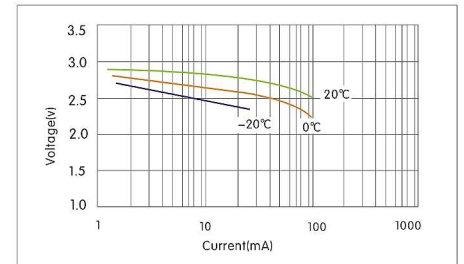

Capacity vs. Current and Temperature

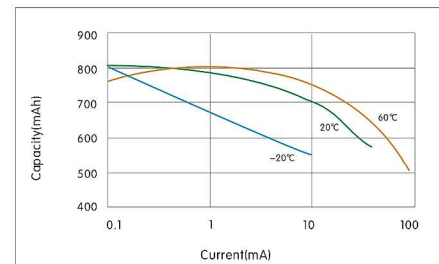

Storage Characteristics

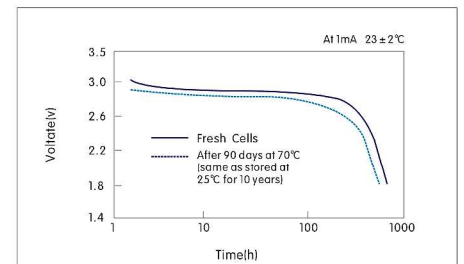



CP 502440

Performance data

(Typical values relative to cells stored for one year or less at 30°C max)

- Nominal capacity 1200mAh
(at 1.0mA +25°C 1.8V cut-off)
- Nominal voltage 3.0V
- Max. continuous current 120mA
(At +25°C 1.8V cut-off, up to 50% of nominal capacity)
- Max. pulse current 400mA
15 second pulses to 1.8V cut-off,
(drained from half-discharged cells at 1.0mA 25°C)
- Operating temperature range -20°C~+60°C
- Weight Approx. 7.8g

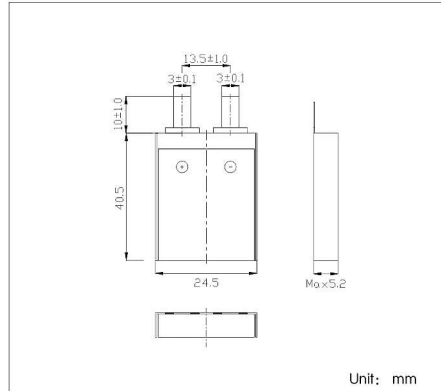

Customized designs are available

Typical discharge curves at 25°C

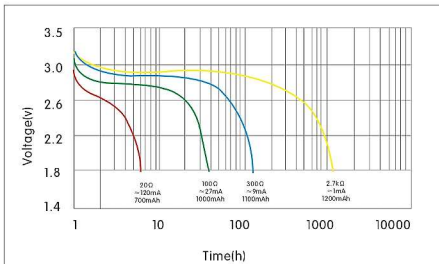

Voltage vs. Current and Temperature

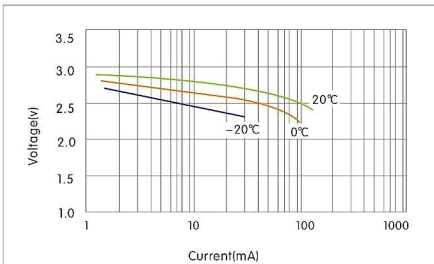

Capacity vs. Current and Temperature

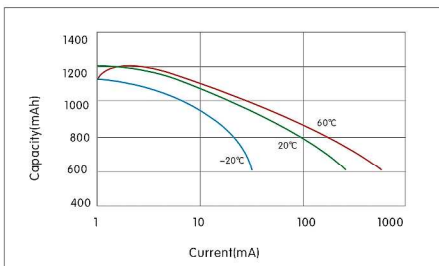

Storage Characteristics

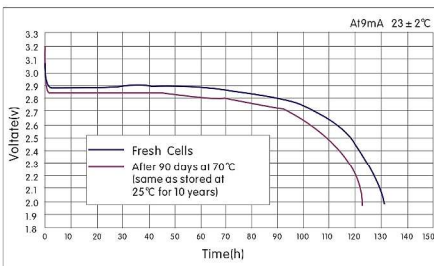

CP 383047

Performance data

(Typical values relative to cells stored for one year or less at 30°C max)

- Nominal capacity 1350mAh
(at 5mA +25°C 1.8V cut-off)
- Nominal voltage 3.0V
- Max. continuous current 400mA
(At +25°C 1.8V cut-off, up to 50% of nominal capacity)
- Max. pulse current 700mA
15 second pulses to 1.8V cut-off,
(drained from half-discharged cells at 5mA 25°C)
- Operating temperature range -20°C~+60°C
- Weight Approx. 9.5g

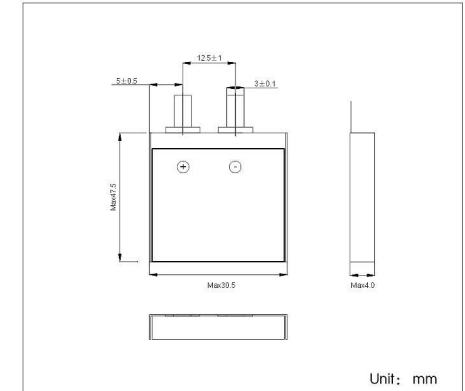

Customized designs are available

Typical discharge curves at 25°C

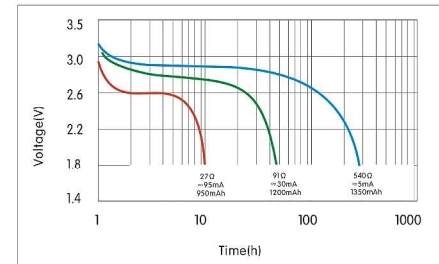

Voltage vs. Current and Temperature

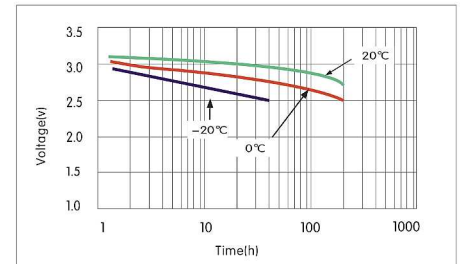

Capacity vs. Current and Temperature

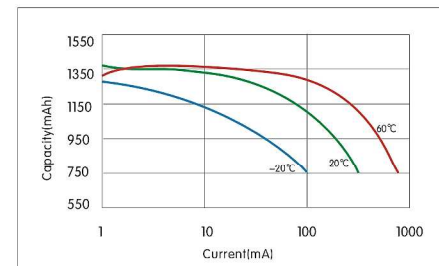

Storage Characteristics

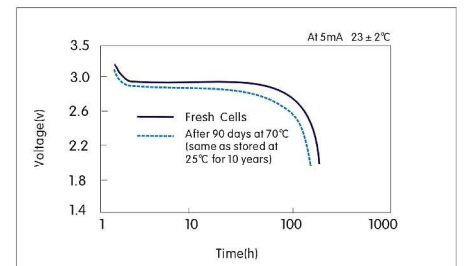



CP 305050

Performance data

(Typical values relative to cells stored for one year or less at 30°C max)

- Nominal capacity 1600mAh
(at 5mA +25°C 1.8V cut-off)
- Nominal voltage 3.0V
- Max. continuous current 600mA
(At +25°C 1.8V cut-off, up to 50% of nominal capacity)
- Max. pulse current 1200mA
15 second pulses to 1.8V cut-off,
(drained from half-discharged cells at 5mA 25°C)
- Operating temperature range -20°C~+60°C
- Weight Approx. 14g

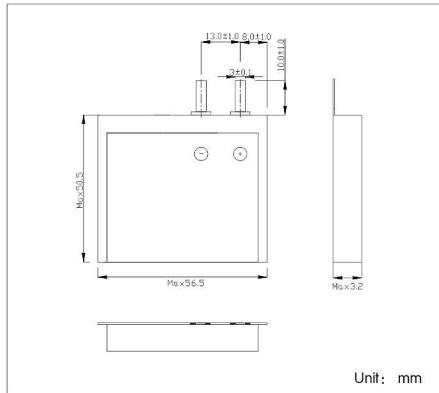

Unit: mm

Customized designs are available

Typical discharge curves at 25°C

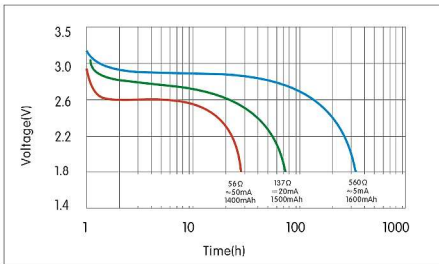

Voltage vs. Current and Temperature

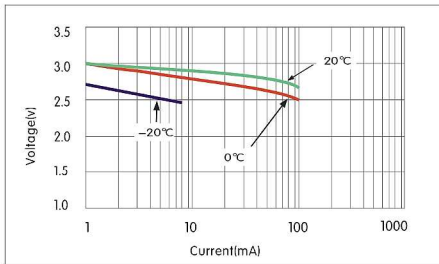

Capacity vs. Current and Temperature

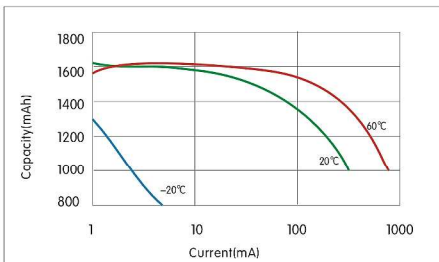

Storage Characteristics

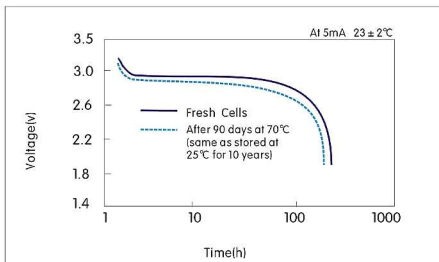

CP 505050

Performance data

(Typical values relative to cells stored for one year or less at 30°C max)

- Nominal capacity 3000mAh
(at 10mA +25°C 1.8V cut-off)
- Nominal voltage 3.0V
- Max. continuous current 1200mA
(At +25°C 1.8V cut-off, up to 50% of nominal capacity)
- Max. pulse current 2500mA
15 second pulses to 1.8V cut-off,
(drained from half-discharged cells at 10mA 25°C)
- Operating temperature range -20°C~+60°C
- Weight Approx. 23g

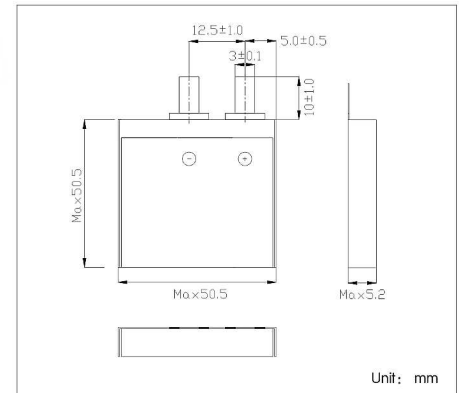

Unit: mm

Customized designs are available

Typical discharge curves at 25°C

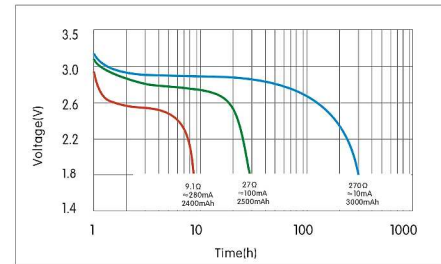

Voltage vs. Current and Temperature

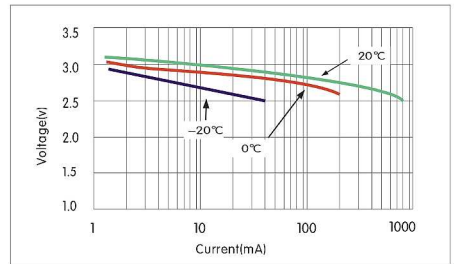

Capacity vs. Current and Temperature

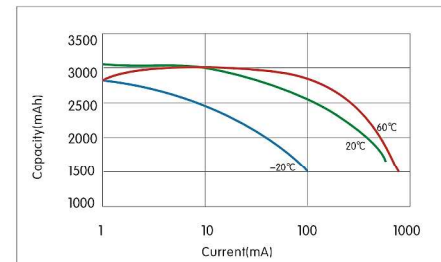

Storage Characteristics

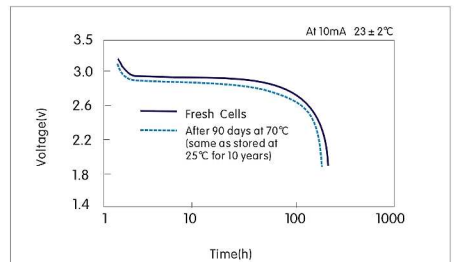

CP9V 1200mAh

Performance data

(Typical values relative to cells stored for one year or less at 30°C max)

- Nominal capacity 1200mAh
(at 1.0mA +25°C 5.4V cut-off)
- Nominal voltage 9.0V
- Max continuous current 120mA
(At +25°C 5.4V cut-off, up to 50% of nominal capacity)
- Max pulse current 400mA
15 second pulses to 5.4V cut-off,
(drained from half-discharged cells at 1mA 25°C)
- Operating temperature range -20°C~+60°C
- Weight Approx. 29g

Typical discharge curves at 25°C

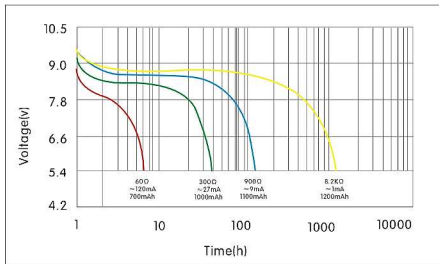

Capacity vs. Current (5.4V cut-off)

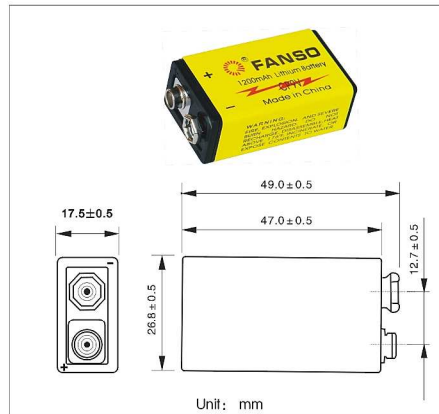
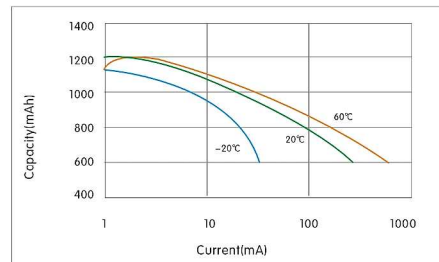

Key features:

- High and stable operating voltage
- Low self-discharge rate (less than 2% at 20°C)
- Hermetic glass-to-metal sealing
- Compliant with IEC86-4 safety standard
- Non-restricted for transport

Main appliances

- Utility metering
- Alarm and security devices
- Memory back-up power
- Smoke detectors
- Professional electronics
- Real-time clock

Voltage vs. Temperature

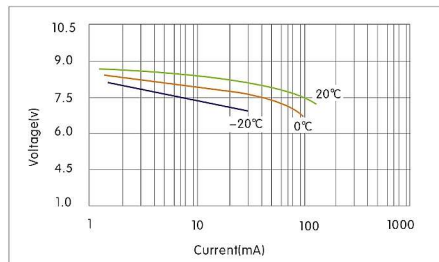

Terminals for single cells (can be customized)

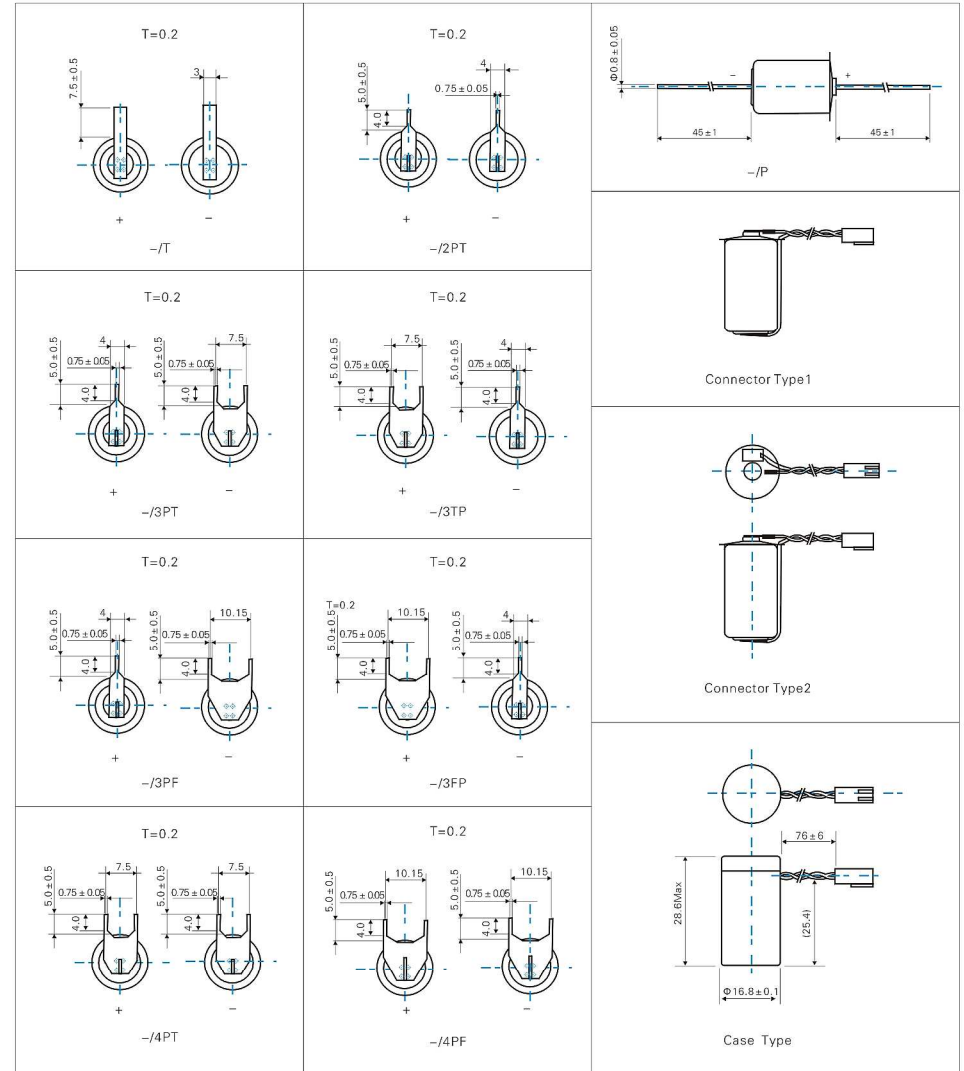

Advanced manufacturing capability

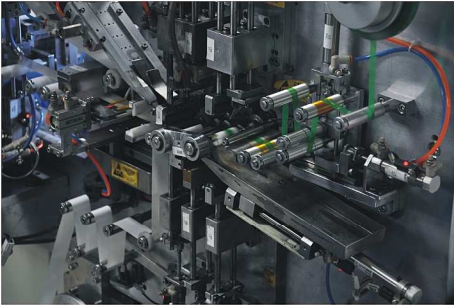

Qualifications

